

## Low power single voltage comparator

### Features

- Wide single supply voltage range or dual supplies +2V to +34V or  $\pm 1V$  to  $\pm 17V$
- Very low supply current (0.2mA) independent of supply voltage (1mW/comparator at +5V)
- Low input bias current: 25nA typ.
- Low input offset current:  $\pm 5nA$  typ.
- Low input offset voltage:  $\pm 1mV$  typ.
- Input common-mode voltage range includes ground
- Low output saturation voltage: 250mV typ. ( $I_O = 4mA$ )
- Differential input voltage range equal to the supply voltage
- TTL, DTL, ECL, CMOS compatible outputs

### Description

These devices consist of a low power voltage comparator designed specifically to operate from a single supply over a wide range of voltages. Operation from split power supplies is also possible.

This comparator also has a unique characteristic in that the input common-mode voltage range includes ground even though operated from a single power supply voltage.

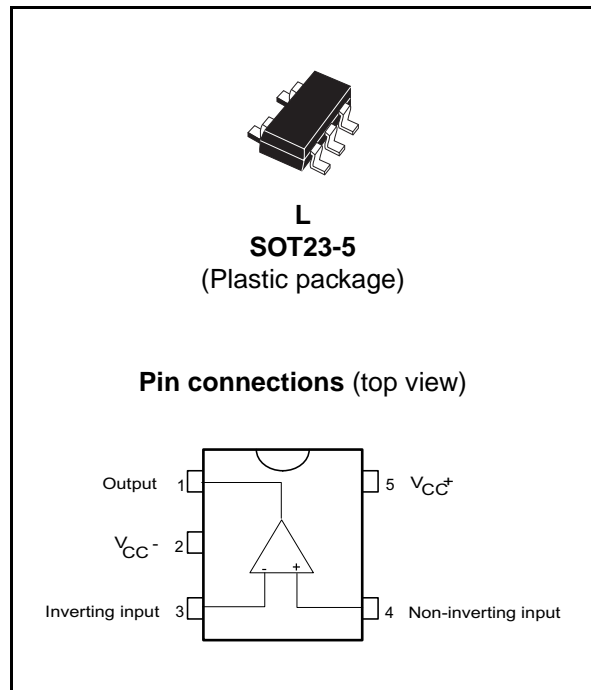

# 1 Schematic diagram

Figure 1. Schematic diagram

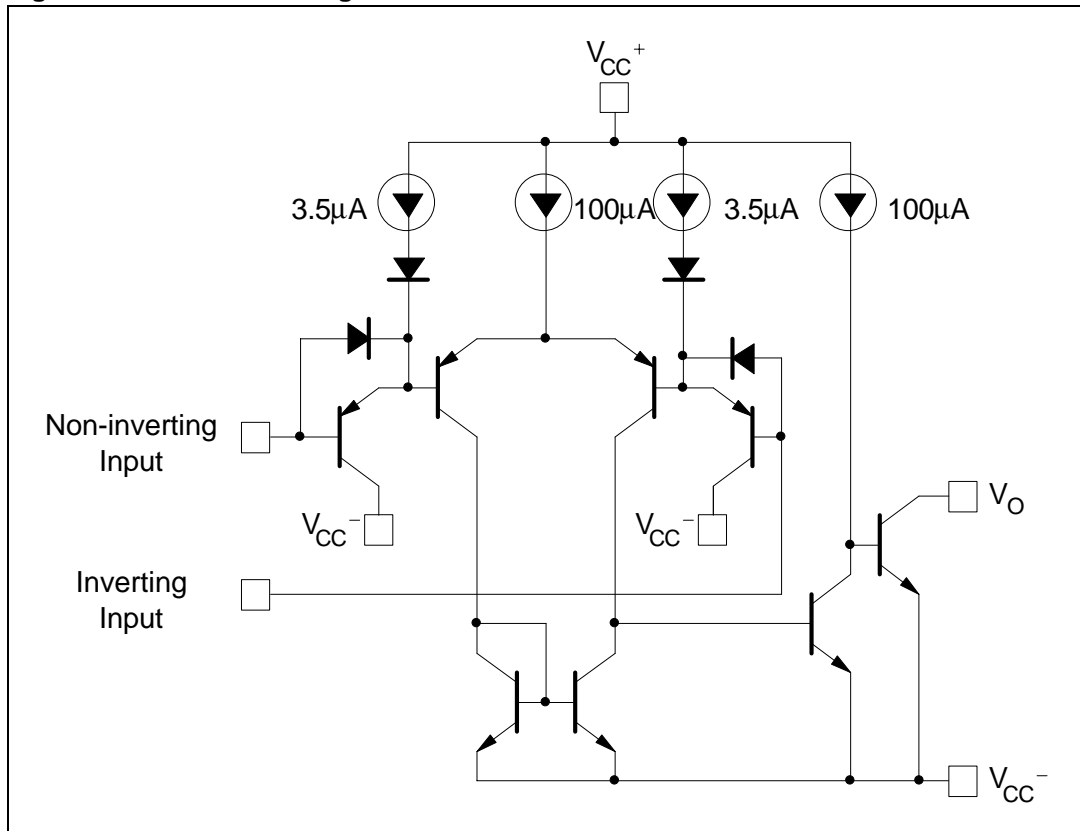

## 2 Absolute maximum ratings and operating conditions

**Table 1. Absolute maximum ratings (AMR)**

Symbol	Parameter	Value	Unit
$V_{CC}$	Supply voltage	$\pm 18$ or 34	V
$V_{id}$	Differential input voltage	$-\pm 34$	V
$V_i$	Input voltage	-0.3 to +34	V
	Output short-circuit to ground <sup>(1)</sup>	Infinite	
$T_j$	Maximum junction temperature	150	°C
$R_{thja}$	Thermal resistance junction to ambient <sup>(2)</sup>	250	°C/W
$R_{thjc}$	Thermal resistance junction to case <sup>(2)</sup>	81	°C/W
$T_{stg}$	Storage temperature range	-65 to +150	°C
ESD	HBM: human body model <sup>(3)</sup>	300	V
	MM: machine model <sup>(4)</sup>	200	

- Short-circuits from the output to  $V_{CC}^+$  can cause excessive heating and potential destruction. The maximum output current is approximately 20mA independent of the magnitude of  $V_{CC}^+$ .
- Short-circuits can cause excessive heating. These values are typical.
- Human body model: A 100pF capacitor is charged to the specified voltage, then discharged through a 1.5k $\Omega$  resistor between two pins of the device. This is done for all couples of connected pin combinations while the other pins are floating.
- Machine model: A 200pF capacitor is charged to the specified voltage, then discharged directly between two pins of the device with no external series resistor (internal resistor < 5 $\Omega$ ). This is done for all couples of connected pin combinations while the other pins are floating.

**Table 2. Operation conditions**

Symbol	Parameter	Value	Unit
$V_{CC}$	Supply voltage	2 to 34 $\pm 1$ to $\pm 17$	V
$V_{icm}$	Input common mode voltage range <sup>(1)</sup> $T_{amb} = 25^\circ\text{C}$ $T_{min} \leq T_{amb} \leq T_{max}$	0 to $V_{CC}^+ - 1.5$ 0 to $V_{CC}^+ - 2$	V
$T_{oper}$	Operating free air temperature range	-40 to +125	°C

- The input common-mode voltage of either input signal voltage should not be allowed to go negative by more than 0.3V. The upper end of the common-mode voltage range is  $V_{CC}^+ - 1.5\text{V}$ , but either or both inputs can go to +30V without damage.

### 3 Electrical characteristics

**Table 3.**  $V_{CC}^+ = +5V$ ,  $V_{CC}^- = 0V$ ,  $T_{amb} = 25^\circ C$  (unless otherwise specified)

Symbol	Parameter	Test conditions	Min.	Typ.	Max.	Unit
$V_{io}$	Input offset voltage <sup>(1)</sup>	$T_{min} \leq T_{amb} \leq T_{max}$		1	5 9	mV
$I_{io}$	Input offset current	$T_{min} \leq T_{amb} \leq T_{max}$		5	50 150	nA
$I_{ib}$	Input bias current <sup>(2)</sup>	$T_{min} \leq T_{amb} \leq T_{max}$		25	250 400	nA
$A_{vd}$	Large signal voltage gain	$V_{CC}^+ = 15V$ , $R_L = 15k\Omega$ $V_o = 1$ to $11V$	50	200		V/mV
$I_{CC}$	Supply current	$V_{CC}^+ = 5V$ , no load $V_{CC}^+ = 30V$ , no load		0.2 0.5	0.5 1.25	mA
$V_{id}$	Differential input voltage <sup>(3)</sup>				$V_{CC}^+$	V
$I_{sink}$	Output sink current	$V_{id} = -1V$ , $V_o = 1.5V$	6	16		mA
$V_{OL}$	Low level output voltage	$V_{id} = 1V$ , $V_{CC}^+ = V_o = 30V$ $T_{min} \leq T_{amb} \leq T_{max}$		250	400 700	mV
$I_{OH}$	High level output current	$V_{id} = 1V$ , $V_{CC}^+ = V_o = 30V$ $T_{min} \leq T_{amb} \leq T_{max}$		0.1	1	nA $\mu A$
$t_{re}$	Small signal response time	$R_L = 5.1k\Omega$ to $V_{CC}^+$ <sup>(4)</sup>		1.3		$\mu s$
$t_{rel}$	Large signal response time	$V_i = TTL$ , $V_{ref} = +1.4V$ , $R_L = 5.1k\Omega$ to $V_{CC}^+$		300		ns

1. At output switch point,  $V_o \approx 1.4V$ ,  $R_S = 0\Omega$  with  $V_{CC}^+$  from 5V to 30V and over the full input common-mode range (0V to  $V_{CC}^+ - 1.5V$ ).
2. The direction of the input current is out of the IC due to the PNP input stage. This current is essentially constant, independent of the state of the output, so there is no loading charge on the reference or input lines.
3. Positive excursions of input voltage may exceed the power supply level. As long as the other voltage remains within the common-mode range, the comparator will provide a proper output state. The low input voltage state must not be less than  $-0.3V$  (or  $0.3V$  below the negative power supply, if used).
4. The response time specified is for a 100mV input step with 5mV overdrive. For larger overdrive signals, 300ns can be obtained.

Figure 2. Supply current vs. supply voltage

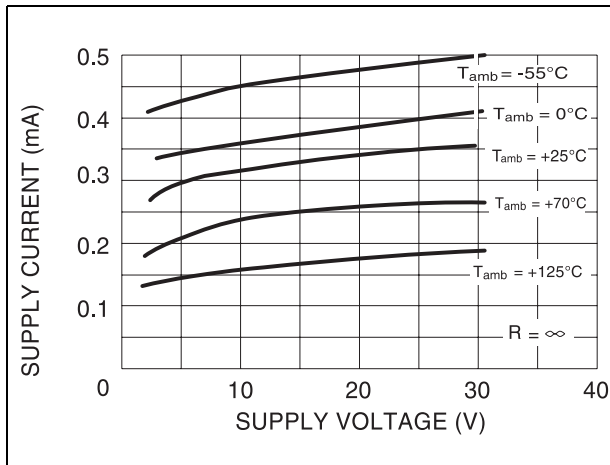

Figure 3. Response time for various input overdrives - negative transition

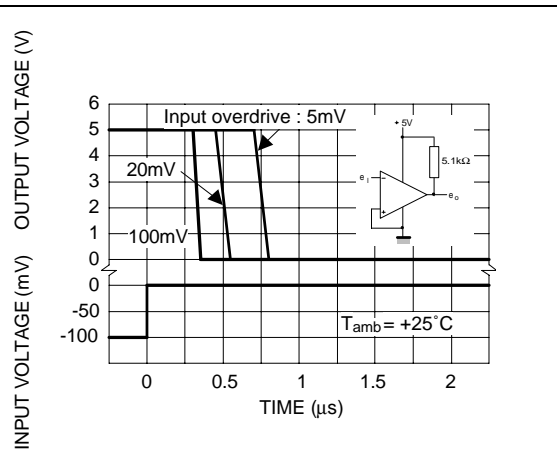

Figure 4. Input current vs. supply voltage

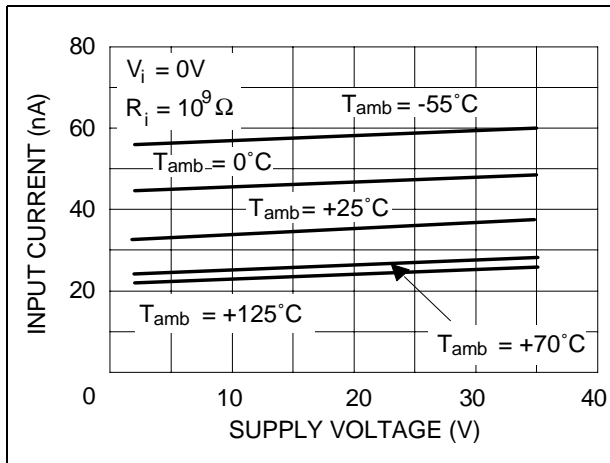

Figure 5. Response time for various input overdrives - positive transition

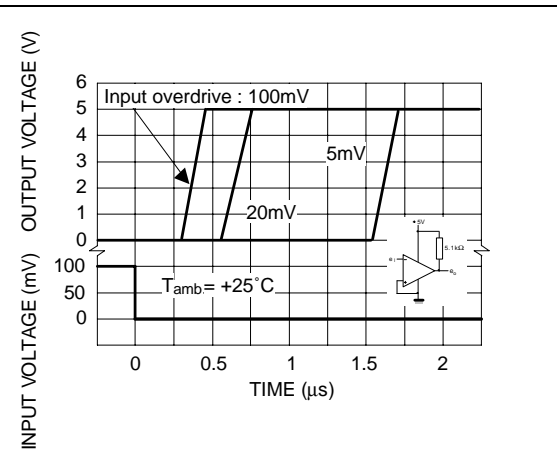
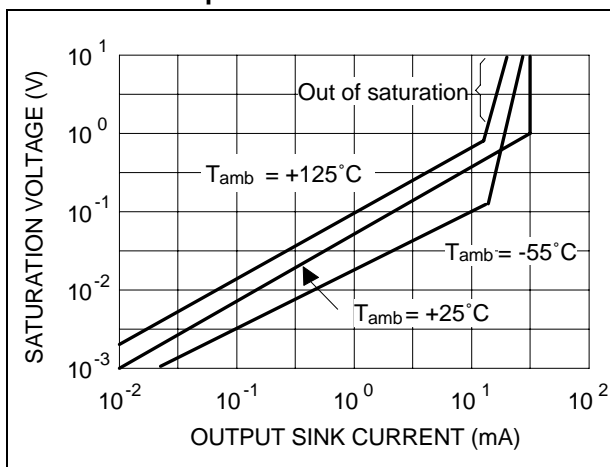

Figure 6. Output saturation voltage vs. output current



## 4 Package information

In order to meet environmental requirements, ST offers these devices in ECOPACK<sup>®</sup> packages. These packages have a lead-free second level interconnect. The category of second level interconnect is marked on the package and on the inner box label, in compliance with JEDEC Standard JESD97. The maximum ratings related to soldering conditions are also marked on the inner box label. ECOPACK is an ST trademark. ECOPACK specifications are available at: [www.st.com](http://www.st.com).

**Figure 7. SOT23-5L package mechanical drawing**

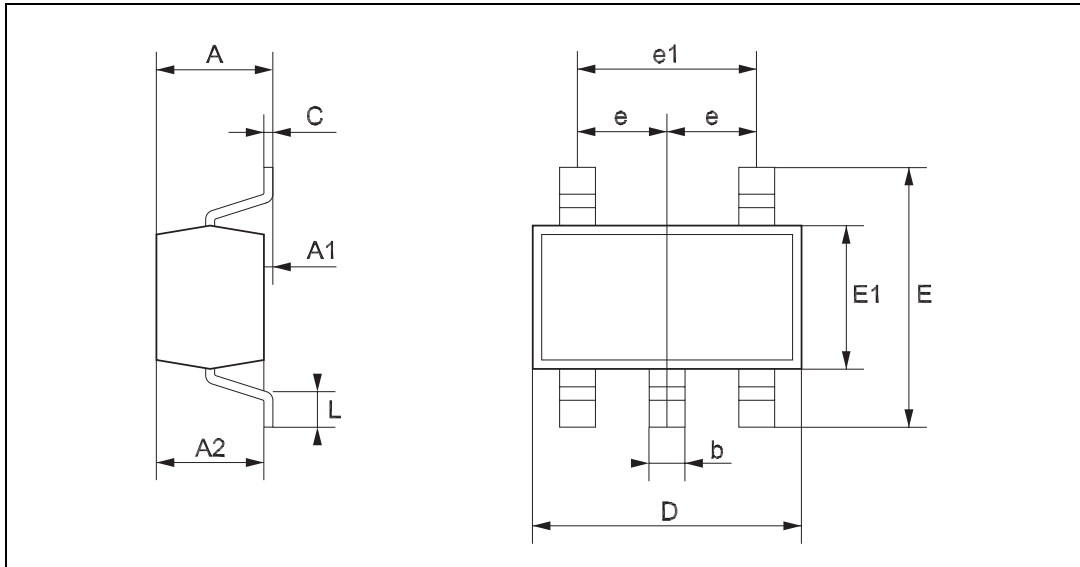

**Table 4. SOT23-5L package mechanical data**

Ref.	Dimensions					
	Millimeters			Mils		
	Min.	Typ.	Max.	Min.	Typ.	Max.
A	0.90		1.45	35.4		57.1
A1	0.00		0.15	0.00		5.9
A2	0.90		1.30	35.4		51.2
b	0.35		0.50	13.7		19.7
C	0.09		0.20	3.5		7.8
D	2.80		3.00	110.2		118.1
E	2.60		3.00	102.3		118.1
E1	1.50		1.75	59.0		68.8
e		0.95			37.4	
e1		1.9			74.8	
L	0.35		0.55	13.7		21.6

## 5 Ordering information

**Table 5. Order codes**

Part number	Temperature range	Package	Packaging	Marking
TS391ILT	-40°C, +125°C	SOT23-5L	Tape & reel	K511
TS391IYLT <sup>(1)</sup>		SOT23-5L (Automotive grade)		K510

1. Qualification and characterization according to AEC Q100 and Q003 or equivalent, advanced screening according to AEC Q001 & Q 002 or equivalent are on-going.

## 6 Revision history

**Table 6. Document revision history**

Date	Revision	Changes
22-Sep-2004	1	Initial release.
6-Jan-2006	2	PPAP reference inserted in the document.
21-Nov-2007	3	Added values for $R_{thja}$ , $R_{thjc}$ and ESD in <a href="#">Table 1: Absolute maximum ratings (AMR)</a> . Added footnote for automotive grade order code in order codes table. Updated format.

**Please Read Carefully:**

Information in this document is provided solely in connection with ST products. STMicroelectronics NV and its subsidiaries ("ST") reserve the right to make changes, corrections, modifications or improvements, to this document, and the products and services described herein at any time, without notice.

All ST products are sold pursuant to ST's terms and conditions of sale.

Purchasers are solely responsible for the choice, selection and use of the ST products and services described herein, and ST assumes no liability whatsoever relating to the choice, selection or use of the ST products and services described herein.

No license, express or implied, by estoppel or otherwise, to any intellectual property rights is granted under this document. If any part of this document refers to any third party products or services it shall not be deemed a license grant by ST for the use of such third party products or services, or any intellectual property contained therein or considered as a warranty covering the use in any manner whatsoever of such third party products or services or any intellectual property contained therein.

**UNLESS OTHERWISE SET FORTH IN ST'S TERMS AND CONDITIONS OF SALE ST DISCLAIMS ANY EXPRESS OR IMPLIED WARRANTY WITH RESPECT TO THE USE AND/OR SALE OF ST PRODUCTS INCLUDING WITHOUT LIMITATION IMPLIED WARRANTIES OF MERCHANTABILITY, FITNESS FOR A PARTICULAR PURPOSE (AND THEIR EQUIVALENTS UNDER THE LAWS OF ANY JURISDICTION), OR INFRINGEMENT OF ANY PATENT, COPYRIGHT OR OTHER INTELLECTUAL PROPERTY RIGHT.**

**UNLESS EXPRESSLY APPROVED IN WRITING BY AN AUTHORIZED ST REPRESENTATIVE, ST PRODUCTS ARE NOT RECOMMENDED, AUTHORIZED OR WARRANTED FOR USE IN MILITARY, AIR CRAFT, SPACE, LIFE SAVING, OR LIFE SUSTAINING APPLICATIONS, NOR IN PRODUCTS OR SYSTEMS WHERE FAILURE OR MALFUNCTION MAY RESULT IN PERSONAL INJURY, DEATH, OR SEVERE PROPERTY OR ENVIRONMENTAL DAMAGE. ST PRODUCTS WHICH ARE NOT SPECIFIED AS "AUTOMOTIVE GRADE" MAY ONLY BE USED IN AUTOMOTIVE APPLICATIONS AT USER'S OWN RISK.**

Resale of ST products with provisions different from the statements and/or technical features set forth in this document shall immediately void any warranty granted by ST for the ST product or service described herein and shall not create or extend in any manner whatsoever, any liability of ST.

ST and the ST logo are trademarks or registered trademarks of ST in various countries.

Information in this document supersedes and replaces all information previously supplied.

The ST logo is a registered trademark of STMicroelectronics. All other names are the property of their respective owners.

© 2007 STMicroelectronics - All rights reserved

STMicroelectronics group of companies

Australia - Belgium - Brazil - Canada - China - Czech Republic - Finland - France - Germany - Hong Kong - India - Israel - Italy - Japan - Malaysia - Malta - Morocco - Singapore - Spain - Sweden - Switzerland - United Kingdom - United States of America

[www.st.com](http://www.st.com)